

Post Calculus Research in Undergraduate Mathematics Education (PC RUME)

Chris Rasmussen	Megan Wawro
San Diego State University	Virginia Tech

Michigan State University, Feb. 18, 2015

Growth of RUME

- Annual RUME conference in North America
- Biannual DELTA conference in southern hemisphere
- Biannual university mathematics education research working group at CERME
- New International Network of Didactics Research in University Mathematics (INDRUM) and biannual conference in Europe
- New *International Journal of Research in Undergraduate Mathematics Education* published by Springer

RUME Research Trajectory

Similar to the K-12 literature, RUME has followed a pattern of

- Identifying and studying student difficulties and cognitive obstacles followed by
- Investigations of the processes by which students learn particular concepts, evolving into
- Classroom studies (or close approximations thereof), including the effects of curricular and pedagogical innovations on student learning, and, more recently
- Research on teacher (including graduate student instructor, lecturers, etc.) knowledge, beliefs, and practices.

The Cycle of Knowledge Production and Improvement of Practice (RAND, 2003)

RAND MR1643-1.1

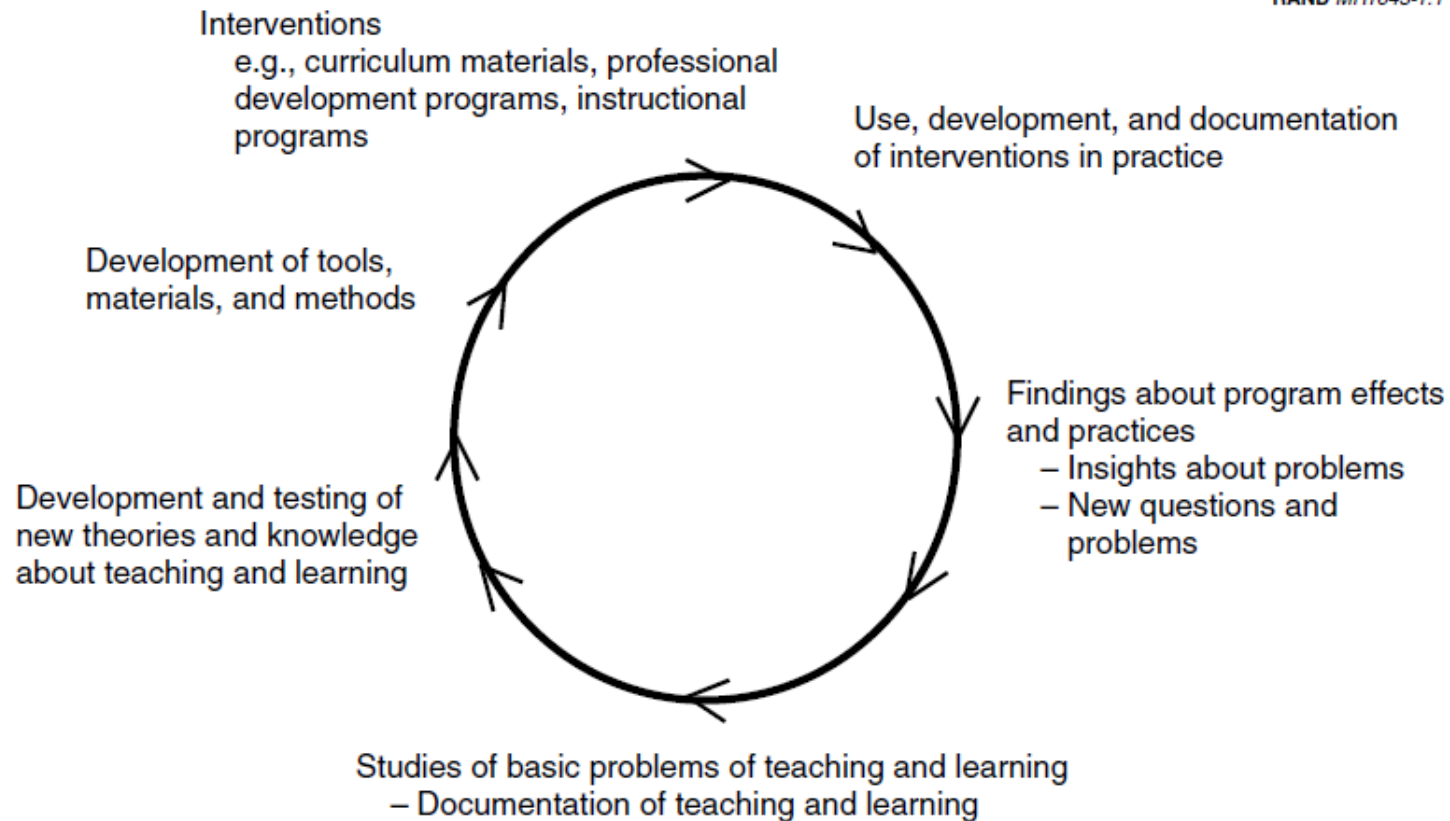

Figure 1.1—Cycle of Knowledge Production and Improvement of Practice

Post Calculus RUME Chapter

- Follow up to 2007 NCTM Handbook chapter by Artigue, Batanero, and Kent
- Reviewed over 200 articles published since 2005
- Chapter organized as follows:
 - Content driven research: student learning of
 - **Linear Algebra**
 - Differential Equations
 - Analysis
 - Abstract Algebra
 - **Teaching of PC mathematics**
 - Areas of growth
 - Mathematical practices
 - Connections to other STEM domains
 - **Promising theoretical / methodological approaches**

Linear Algebra

- Started with the 2007 handbook - linear algebra research review dominated by *The Teaching and Learning of Linear Algebra*, edited by Dorier (2000). Three themes from this prior work:
 - categorizations for students' reasoning
 - discussions of the various ways in which geometric reasoning could (or should) be leveraged
 - the “object of formalism” and its accompanying difficulties for students
- Identified 54 papers, with 36 of being of sufficient quality for further consideration

Studies of student reasoning → frameworks and methodological tools: Three examples

- $A\mathbf{x} = \mathbf{b}$ (Larson & Zandieh, 2013)
- The invertible matrix theorem Selinski, Rasmussen, Wawro, & Zandieh, 2014)
- Span (Stewart & Thomas, 2009)

Studies of mathematicians: One example

- Eigenvectors (Sinclair & Tabaghi, 2010)

Making sense of
 $A\mathbf{x} = \mathbf{b}$

The framework's power is in its potential to help teachers, researchers, and curriculum designers better understand ways of supporting students in developing the ability to move flexibly among interpretations to powerfully leverage the analytic tools of linear algebra.

Interpretation of $A\mathbf{x} = \mathbf{b}$	Symbolic Representation	Geometric Representation
Linear combination (LC) interpretation $x_1\mathbf{a}_1 + x_2\mathbf{a}_2 = \mathbf{b}$	A : set of column vectors $(\mathbf{a}_1, \mathbf{a}_2)$ \mathbf{x} : weights (x_1, x_2) on column vectors of A \mathbf{b} : resultant vector	
System of equations interpretation $a_{11}x_1 + a_{12}x_2 = b_1$ $a_{21}x_1 + a_{22}x_2 = b_2$	A : entries viewed as coefficients $(a_{11}, a_{12}, a_{21}, a_{22})$ \mathbf{x} : solution (x_1, x_2) \mathbf{b} : two real numbers (b_1, b_2)	
Transformation interpretation $T: \mathbf{x} \mapsto \mathbf{b}, T(\mathbf{x}) = A\mathbf{x}$	A : matrix that transforms \mathbf{x} : input vector \mathbf{b} : output vector	

Larson & Zandieh (2013)

Making connections – the invertible matrix theorem (Selinski et al., 2014)

Suppose you have a 3×3 matrix A , and you know that A is invertible. Decide if each of the following statements is true or false, and explain your answer.

- (i) The column vectors of A are linearly independent.
- (ii) The determinant of A is equal to zero.
- (iii) The column vectors of A span \mathbf{R}^3 .
- (iv) The null space of A contains only the zero vector.
- (v) The row-reduced echelon form of A has three pivots.

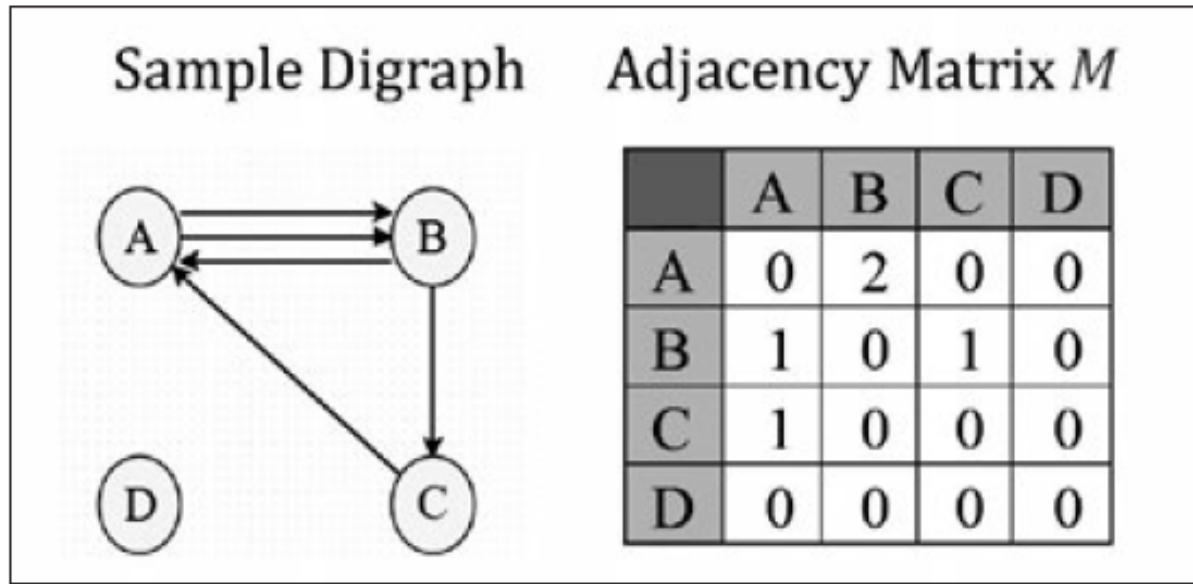

- The method makes use of mathematical constructs from digraph theory, such as walks and being strongly connected, to indicate possible chains of connections and flexibility in making connections within and between concepts.
- Selinski et al. (2014) Illustrate the usefulness of this method for comparing differences in the structure of the connections, as exhibited in what they refer to as **dense, sparse, and hub** adjacency matrices.
- Another contribution of the adjacency matrix method is that it requires the construction of a conceptually structured inventory of students' conceptions.

Span (Stewart & Thomas, 2009)

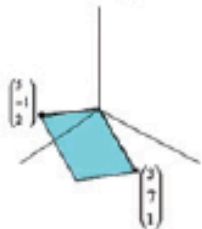
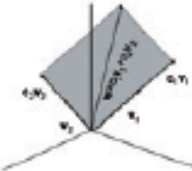
Worlds APOS	Embodied World	Symbolic World		Formal World
		Algebraic Rep.	Matrix Rep.	
Action	<p>Can see that 2 vectors define a plane</p> 	<p>Can calculate elements of $\text{span}\{\mathbf{v}_1, \mathbf{v}_2\}$ e.g. $\mathbf{w} = 2\mathbf{v}_1 + 3\mathbf{v}_2$ \mathbf{w} is a member of $\text{span}\{\mathbf{v}_1, \mathbf{v}_2\}$</p>	<p>Can calculate whether a particular vector \mathbf{v} belongs to a particular span S by Gaussian elimination</p>	
Process	<p>Can see that two linearly independent vectors originating from the same point determine a plane. The set of all points in the plane is the span of these vectors</p> 	<p>$\mathbf{w} = k_1\mathbf{v}_1 + k_2\mathbf{v}_2$ as a general element of $\text{span}\{\mathbf{v}_1, \mathbf{v}_2\}$</p>	<p>Can understand and generalise a method for the content in the above action-matrix cell</p>	<p>Can relate span to other linear algebra concepts such as linear combination, basis and subspace</p>
Object	<p>Can see the resulting plane as an object in its own right</p>			<p>The definition of the span</p>

Stewart and Thomas cite the lack of students' embodied views as a reason why students were "trapped in the symbolic world, unable to move to the formal world of mathematical thinking."

How mathematicians understand eigenvectors and eigenvalues – An embodied cognition analysis (Sinclair & Tabaghi, 2010)

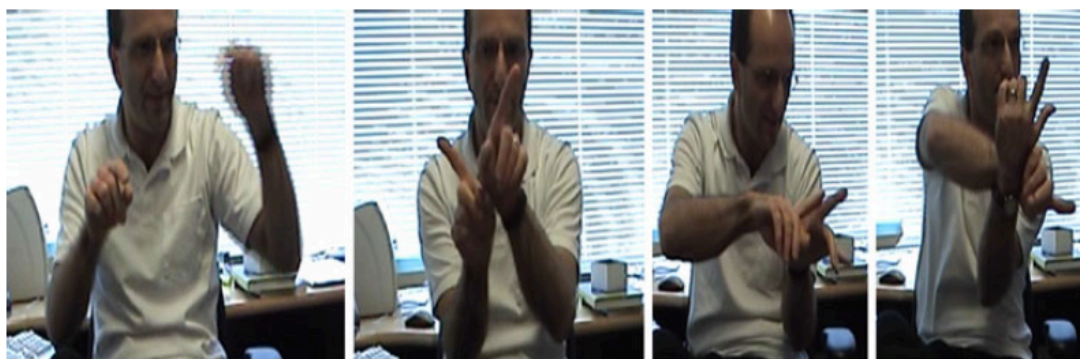

a. move output vector

b. move vector around

c. vectors line up

d. chasing vectors

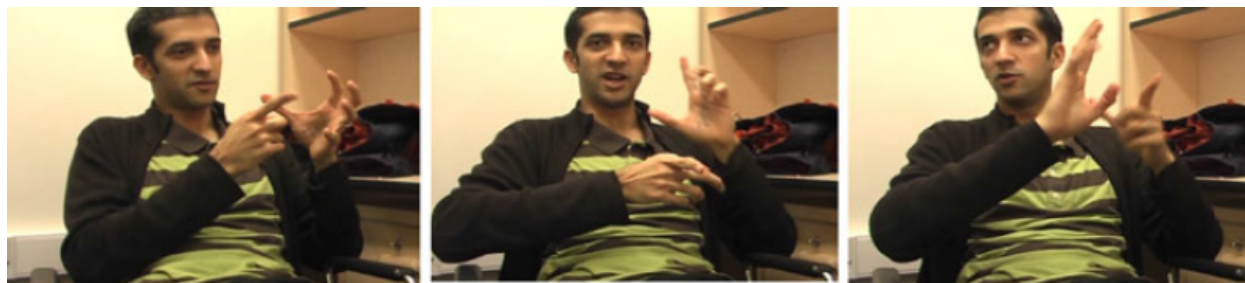

a. right hand showing unit circle

b. vectors bending and twisting

c. vector not changing direction

- Found a prevalence of metaphorical language and gesturing to convey vectors as objects in space that get mapped to their scalar multiples
- Gesture offers more possibility than spoken language for expressing continuity, time and motion

PC RUME Teaching

- The 2007 Handbook chapter contained little to no review of undergraduate mathematics education teaching
- Today situation is quite different – we identified nearly 40 empirical studies that focused on instruction.
 - Research that examines lecture-oriented instruction;
 - Research that examines inquiry-oriented instruction;
 - Research that examines professional development

A Cultural Shift

Lynn Steen (2011, p. 5) in his contribution to the *Project Kaleidoscope 20th Anniversary Essay Collection* writes the following:

Professional meetings of university mathematicians, which in the mid-1980s were predominantly devoted to mathematical research and applications, are today a nearly equal mix of mathematics and mathematics education. For a community steeped in a tradition that focused only on research and exposition of mathematics, the very visible emphasis on teaching and learning is a major change in the culture.

Lecture-oriented instruction

Artemeva and Fox (2011) provide a comprehensive portrait of the writing and talking that occurs in lectures.

- Informed by rhetorical genre studies and communities of practice
- Analyzed 50 different lecture classes from different cultures and content
- Identified the genre they call “Chalk Talk”
- Chalk talk practices include
 - verbalizing everything written on the board,
 - metacommentary about what was written,
 - board choreography,
 - using pointing gestures to highlight key issues, relationships
 - using rhetorical questions to signal transitions, reflection, or to check for understanding.

Lecture-oriented instruction

Using Sfard's (2008) commognitive approach, Viirman (2014) analyzed the lectures of seven different Swedish university mathematics instructors.

- The overall findings support Arteva and Fox's (2011) delineation of the practices that comprise "chalk talk" but also explore in more depth differences between the seven lecturers in the way in which doing mathematics is modeled for learners.
- For example, Viirman detailed differences in the lecturers' routines for constructing definitions
 - By stipulation, which introduces a new concept via a definition.
 - By "saming." In this routine, several examples are presented and then the definition comes out of an examination of what property unites them

Inquiry-oriented instruction

- Freeman et al. (2014) examined 225 studies that compared student achievement in a range of undergraduate STEM courses and found that students in lecture-oriented classes were 1.5 times more likely to fail than were students in inquiry-oriented classes.

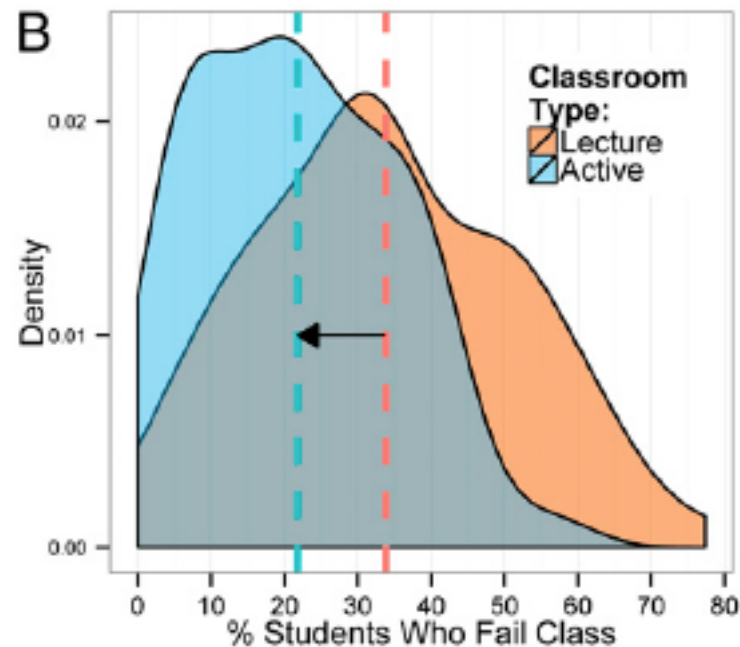

Small scale studies – An inquiry-oriented approach to DEs (Kwon et al., 2005)

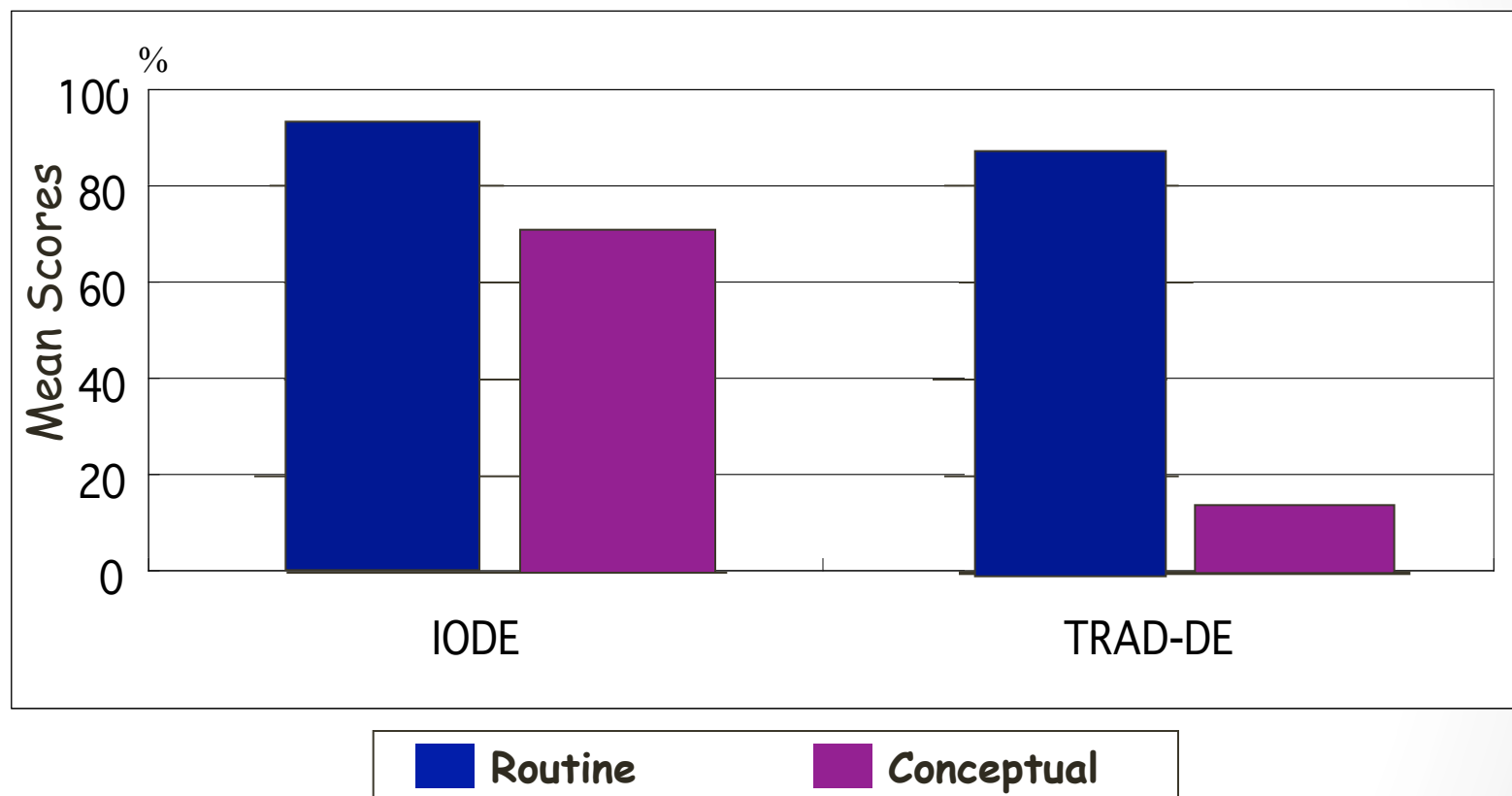

- 4 different sites, N = 111

Students' retention of mathematical knowledge and skills in differential equations

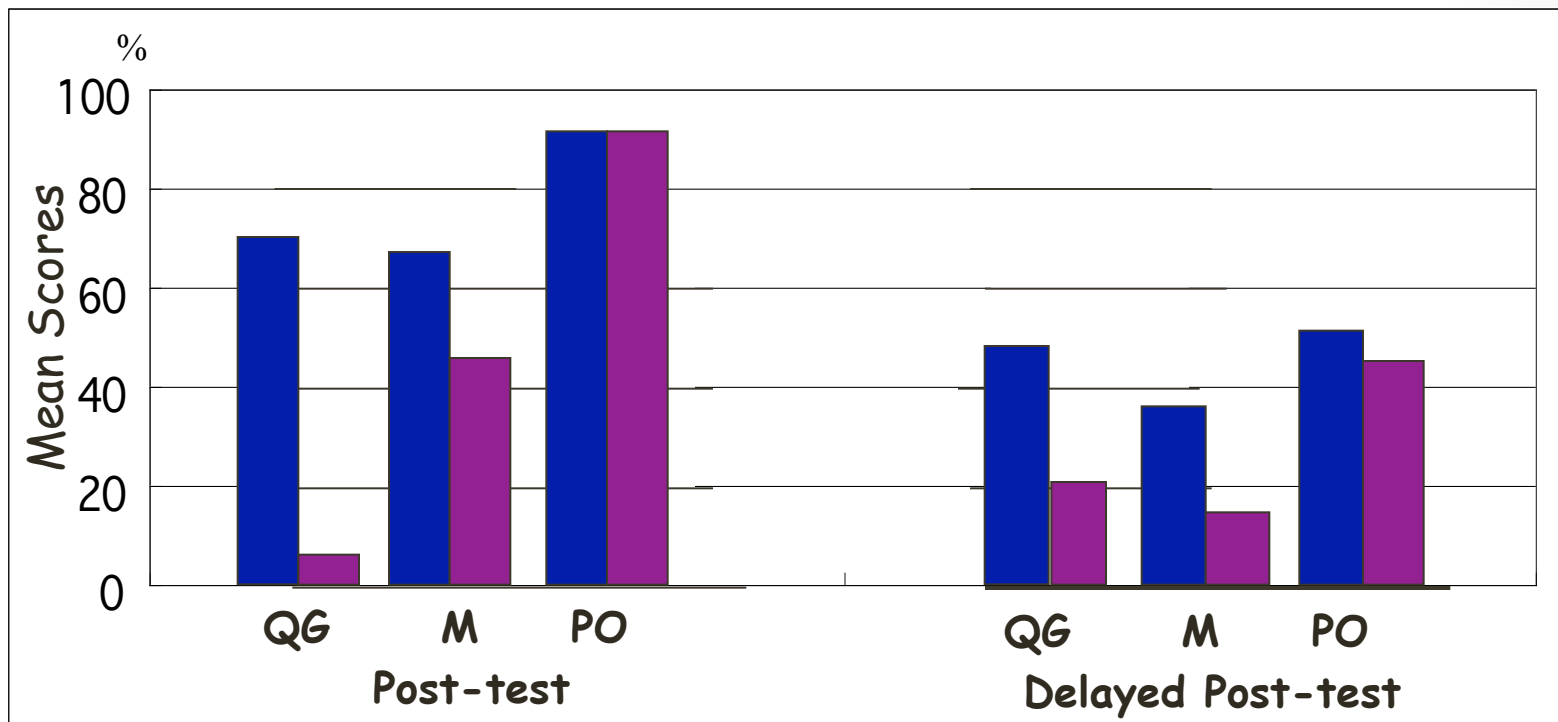

■ IO-DE(n=15) ■ TRAD-DE(n=20)

QG: Qualitatively/Graphically
M: Modeling
PO: Procedurally Oriented

Inquiry-oriented instruction – Gender differences

Laursen et al. (2014, p. 415) report the following:

- In non-IBL [Inquiry-Based Learning] courses, women reported gaining less mastery than did men, but these differences vanished in IBL courses.
- That this apparent deficit can be so readily erased shows that its cause is not a deficit among female students, but rather that non-IBL courses do selective disservice to women. That is, IBL methods do not “fix” women but fix an inequitable course.

Characteristics of Successful Programs in College Calculus

Phase I: Six web-based surveys to identify factors that are correlated with success in Calculus I

207 two-year colleges	→ 40 (19%) participated
134 undergraduate colleges	→ 41 (31%) participated
60 master's universities	→ 21 (35%) participated
120 research universities	→ 66 (55%) participated

Phase II: Case studies of 16 successful calculus programs

Related findings in Calculus I

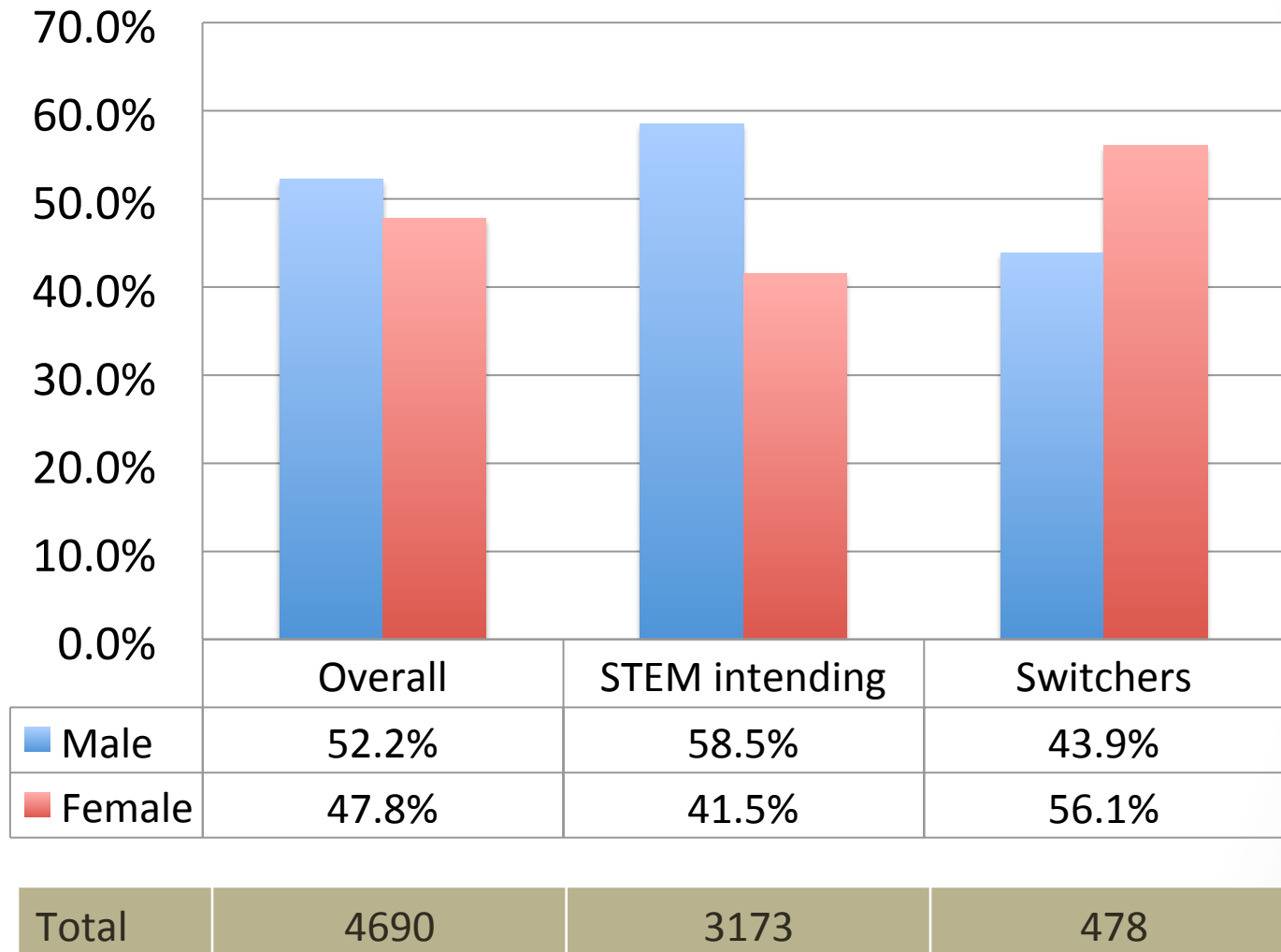

Instructor Pedagogy: Factor analysis

“Good Teaching” and “Ambitious Teaching”

“Good Teaching”

My Calculus Instructor:

- listened carefully to my questions and comments
- allowed time for me to understand difficult ideas
- presented more than one method for solving problems
- asked questions to determine if I understood what was being discussed
- discussed applications of calculus
- encouraged students to seek help during office hours
- frequently prepared extra material
- Assignments were challenging but doable
- My exams were graded fairly
- My calculus exams were a good assessment of what I learned

Instructor Pedagogy: Factor analysis

“Good Teaching” and “Ambitious Teaching”

“Ambitious Teaching”

My Calculus Instructor:

- Required me to explain my thinking on homework and exams
- Required students to work together
- Had students give presentations
- Held class discussions
- Put word problems in the homework and on the exams
- Put questions on the exams unlike those done in class
- Returned assignments with helpful feedback and comments

Jackson, K., Garrison, A., Wilson, J., Gibbons, L., & Shahan, E. (2013). Exploring Relationships Between Setting Up Complex Tasks and Opportunities to Learn in Concluding Whole-Class Discussions in Middle-Grades Mathematics Instruction. *Journal for Research in Mathematics Education*, 44(4), 646–682.

Switcher Rates for Low and High Levels of Good and Ambitious Teaching

	Good Teaching Low	Good Teaching High
Ambitious Teaching Low	16.2%	10.4%
Ambitious Teaching High	11.9%	7.0%

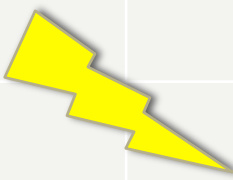

Insights into inquiry-oriented instructional practice

- Kwon et al. (2008) detail the following four different functions of instructor revoicing (O'Connor's & Michaels, 1993): as a binder, as a springboard, for ownership, and as a means for socialization.
- Rasmussen, Zandieh, and Wawro (2009) identify three “brokering moves” that facilitated the emergence and reinvention of a bifurcation diagram. These brokering moves function to forge connections between the different small groups, the classroom community as a whole, and the norms and practices of the broader mathematical community.

Insights into inquiry-oriented instructional practice

- Johnson (2013) identifies a variety of ways in which two abstract algebra instructors engaged in mathematical activity in response to the mathematical activity of their students.
- Wagner, Speer, and Rossa (2007), who examined in depth the teaching of co-author Rossa implementing an inquiry-oriented differential equations curriculum for the first time. They found that the most challenging and difficult jobs for Rossa were pacing and the mathematical work of making sense of students' reasoning, especially in whole class discussions. They used this case as an opportunity to examine the knowledge needed to carry out inquiry-oriented instruction.

Professional Development

Two emergent areas of professional development:

- Collaborations between mathematicians and mathematics education researchers, and
- The creation and use of resources and concomitant professional development opportunities such resources afford.

Collaborations: M's and ME's

- Since 2009, mathematicians and mathematics education researchers in the mathematics department at Auckland University have been engaged in shared exploration and analysis of decisions made and actions taken during lectures (Patterson et al., 2011).
- The professional development group, referred to as DATUM (Discussion and Analysis of the Teaching of Undergraduate Mathematics) typically involves approximately six faculty members who meet regularly to re-examine videorecorded excerpts selected by the lecturer.

Patterson et al. (2011) aptly culls out the significance of this work as follows:

- Creating a forum to discuss the decisions involved in lecturing situations often leads to an awareness of unarticulated, taken as given, orientations and their consequent impact on teaching. Awareness of any inner tension and the need to resolve it is an important part of reflecting on our role as tertiary teachers. Encouraging this engagement can result in effective incremental professional growth. (p. 993)

Resources

- Another *opportunity* for research focusing on the professional development of post calculus mathematics instructors is the use of various resources (textbooks, supplemental material, technologies, workshops, etc.).
- Inquiry-Oriented Linear Algebra web resource
<http://iola.math.vt.edu/u1t1.php>



Unit 1: Linear Independence and Span

Task 1: The Magic Carpet Ride

[Print Lesson »](#)[Expand All](#)[Handout 1: The Carpet Ride Problem »](#)[Lesson Overview »](#)[Learning Goals and Rationale »](#)[Student Thinking »](#)[Implementation »](#)[Videos »](#)[Suggestions for Homework »](#)

Discussion Board

[Expand](#)

Areas for Growth

- Mathematical practices
- Connections to other STEM domains
- **Promising theoretical and methodological approaches**

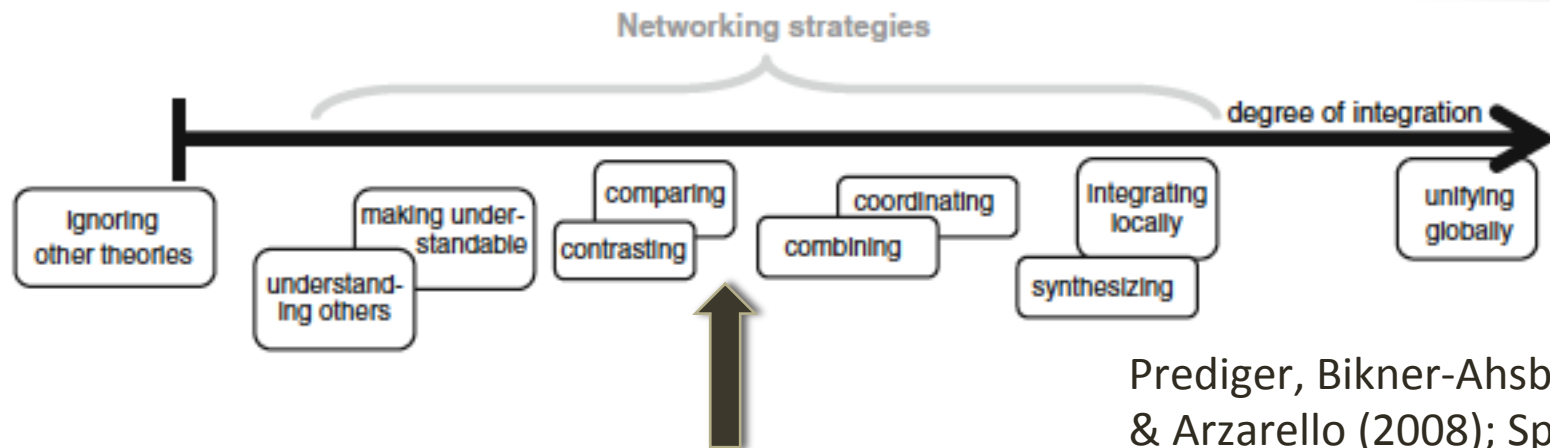

Prediger, Bikner-Ahsbabs,
& Arzarello (2008); Special
issue of RME (2014) edited
by Nardi and colleagues

Why Coordinate?

Diversity of theories poses a number of challenges

- Communicate more effectively among researchers
- Integrate empirical findings from different perspectives
- Improve mathematics classrooms via more coherent research

Potential benefits

- Gain explanatory and descriptive power, especially for design based research and the move to more inquiry-oriented instruction
- Reduce the compartmentalization of theories
- Foster a discourse on theory development

Emergent perspective and the interpretive framework

(Cobb & Yackel, 1996)

Social Perspective	Individual Perspective
Social norms	Beliefs about one's own role, others' role, and the general nature of mathematical activity
Sociomathematical norms	Mathematical beliefs and values
Classroom mathematical practices	Mathematical conceptions and activity

Social Perspective	Individual Perspective
Classroom mathematical practices	Mathematical conceptions and activity

The need to expand the bottom row of the interpretive framework

- “Mathematical conceptions and activity” has primarily been operationalized in terms of individual participation in classroom mathematical practices
- Desire to be more inclusive of cognitive framing and draw on expansive literature that examines individual cognition
- Work in undergraduate mathematics foregrounds disciplinary nature of students’ mathematical activity

Expanded Interpretive Framework

Social Perspective		Individual Perspective	
Social norms		Beliefs about one's own role, others' role, and the general nature of mathematical activity	
Sociomathematical norms		Mathematical beliefs and values	
Disciplinary practices	Classroom mathematical practices	Participation in mathematical activity	Mathematical conceptions

4 constructs and research questions

Disciplinary Practices	Classroom mathematical practices	Participation in mathematical activity	Mathematical conceptions
What is the mathematical progress of the classroom community in terms of the disciplinary practices of mathematics?	What are the normative ways of reasoning that emerge in a particular classroom?	How do individual students contribute to mathematical progress that occurs across small group and whole class settings?	What conceptions do individual students bring to bear in their mathematical work?

Classroom math practices: Ways of reasoning that function as if shared

Three criteria

Criterion 1: When the backing and/or warrants for particular claim are initially present but then drop off

Criterion 2: When certain parts of an argument (the warrant, claim, data, or backing) shift position within subsequent arguments

Criterion 3: When a particular idea is repeatedly used as either data or warrant for different claims across multiple days

Rasmussen & Stephan (2008)

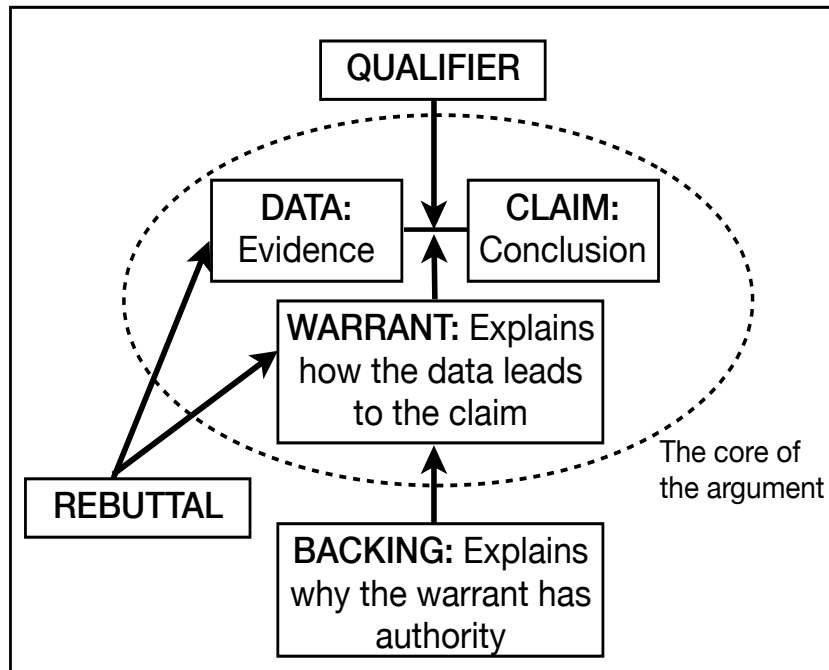

Toulmin (1958)

Disciplinary Practices

Moschkovich (2007) argues that disciplinary practices are “socially, culturally, and historically produced practices that have become normative”. From an a priori perspective, we have:

- Symbolizing
- Algorithmatizing
- Defining
- Modeling
- Theoremizing



Reinventing Euler’s method: Creating predictions, isolating attributes, forming quantities, forging relationships between quantities, expressing relationships symbolically

Using a grounded approach we allow the data to shape how we characterize the features of a disciplinary practice that emerge in a particular class.

Mathematical conceptions

A mathematics conceptions analysis is an acquisition-oriented framing. As students solve problems, explain their thinking, represent their ideas, and make sense of others' ideas, they necessarily bring forth various conceptions of the ideas being discussed and potentially modify their conceptions.

- When feasible, make use of prior work that characterizes student conceptions of particular ideas: concept image of limit (Williams), covariational reasoning (Carlson), etc.
- In less traversed domains, one will need to develop new characterizations of what understanding a particular idea entails.

Participation in mathematical activity

Individual progress as participation in mathematics is operationalized in terms of production and recipient design (Krummheuer; 2007, 2011).

Production design

- *Author* is given when a speaker is responsible for both the content and formulation of an utterance.
- *Relayer* is assigned when a speaker is not responsible for the originality of either the content or formulation of an utterance
- *Ghostee* takes part of the content of a previous utterance and attempts to express a new idea
- *Spokesman* is one who attempts to express the content of a previous utterance in his/her own words

Participation in mathematical activity

Recipient Design

- *Conversation partner* is the listener to whom the speaker seems to allocate the subsequent talking turn
- *Co-hearers* are listeners who are also directly addressed but do not seem to be treated as the next speaker
- *Over-hearers* are those who seem tolerated by the speaker but do not participate in the conversation
- *Eavesdroppers* are listeners who are deliberately excluded by the speaker from conversation

Coordinating across constructs

- Choose an individual and trace his/her utterances for the ways in which they contributed to the emergence of ways of reasoning that function as if shared and/or disciplinary practices
- Characterize the individuals that offer claims, data, warrants, and backing (as related to ways of reasoning that function as if shared)
 - What are their characteristics?
 - What is the instructor's role?
 - How do individual contributions relate to production and recipient design roles?
- How do patterns over time in student participation relate to growth in their mathematical conceptions?
- In what way are different participation patterns correlated with different mathematical growth trajectories?
- In what ways are particular classroom math practices consistent (or inconsistent) with various disciplinary practices?

Where might RUME go next?

- More design based research that examines social and cognitive dimensions of learning and teaching
- Studies of mathematicians as they change their instructional practices, develop and refine their knowledge, skills, and dispositions, and the role of resources in professional development
- Differential effect of different instructional approaches (including new digital technologies) on traditionally underrepresented students
- Continued efforts to build more comprehensive theoretical and methodological approaches
- Deeper insights into how concepts and practices are interpreted, represented, talked about, and applied in different ways in the various STEM disciplines
- Studies that examine curricular innovations and coherence across courses

The end – thanks for listening

Chris Rasmussen

chris.rasmussen@ sdsu.edu